

**Gerth Stølting Brodal**

Aarhus Universitet

[www.cs.au.dk/~gerth/julehjerter](http://www.cs.au.dk/~gerth/julehjerter)

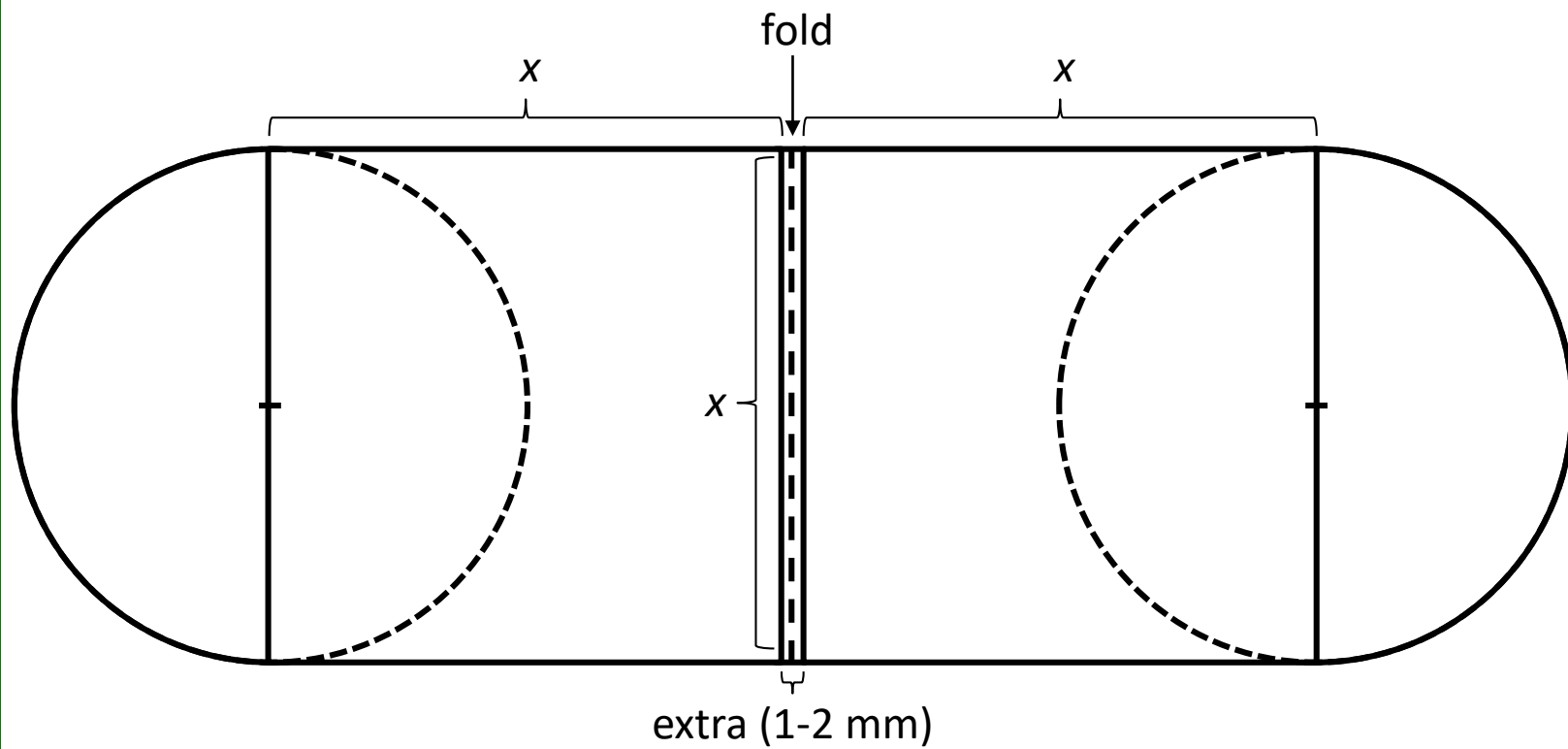

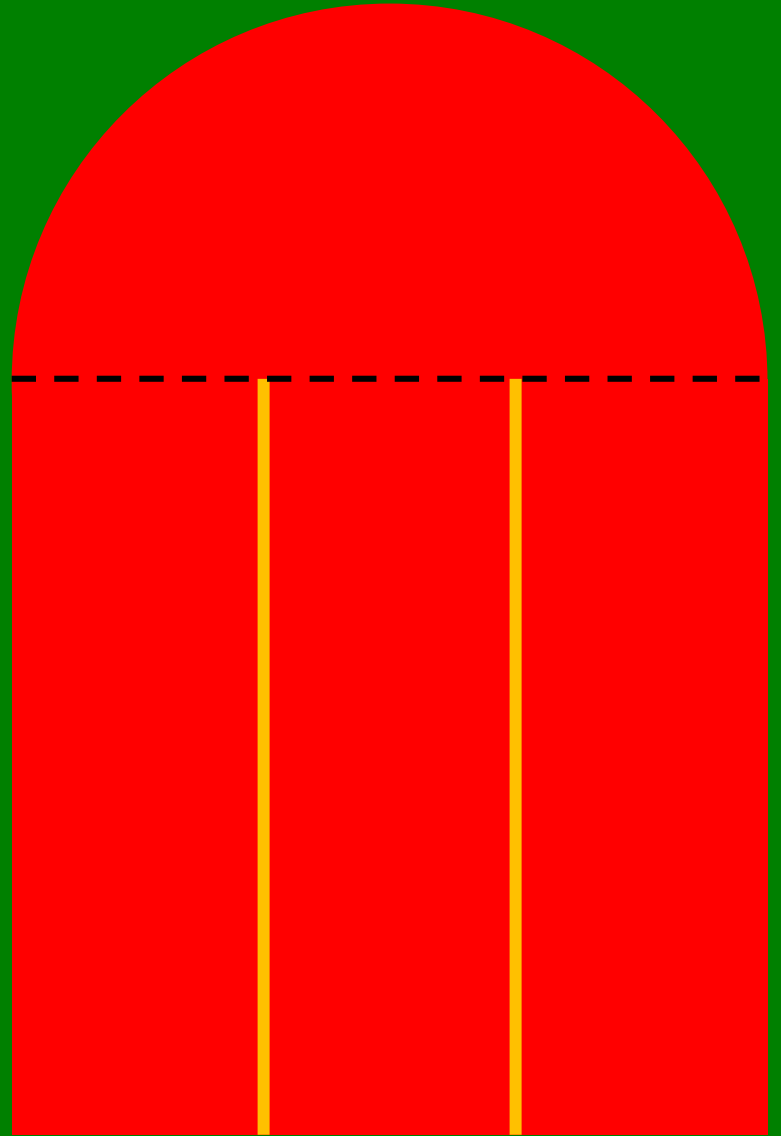
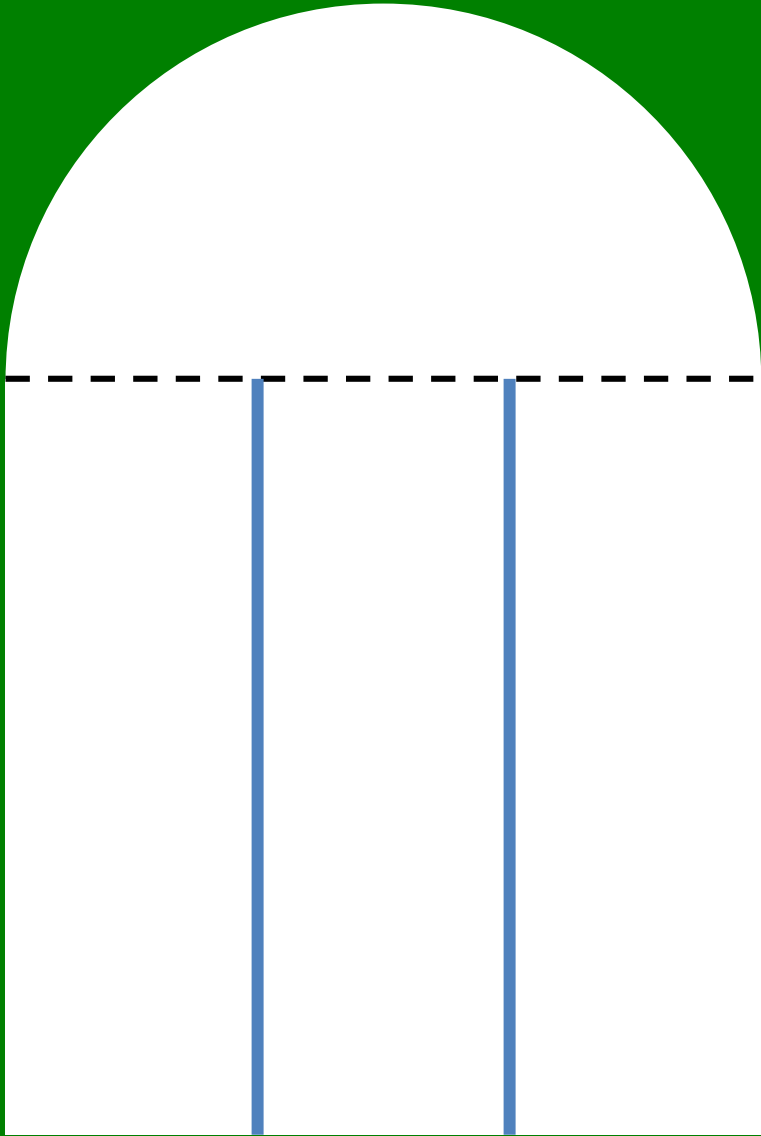

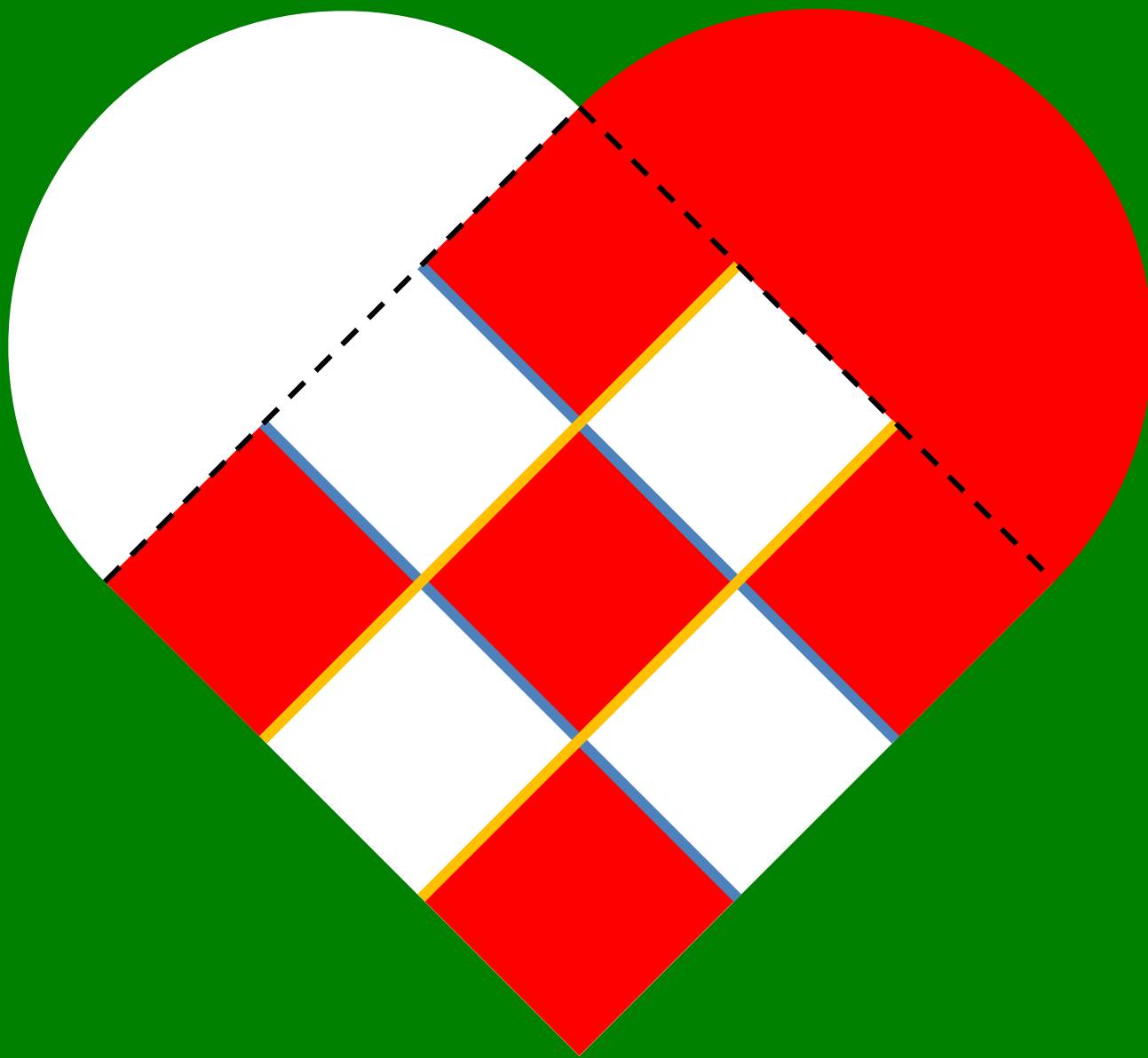

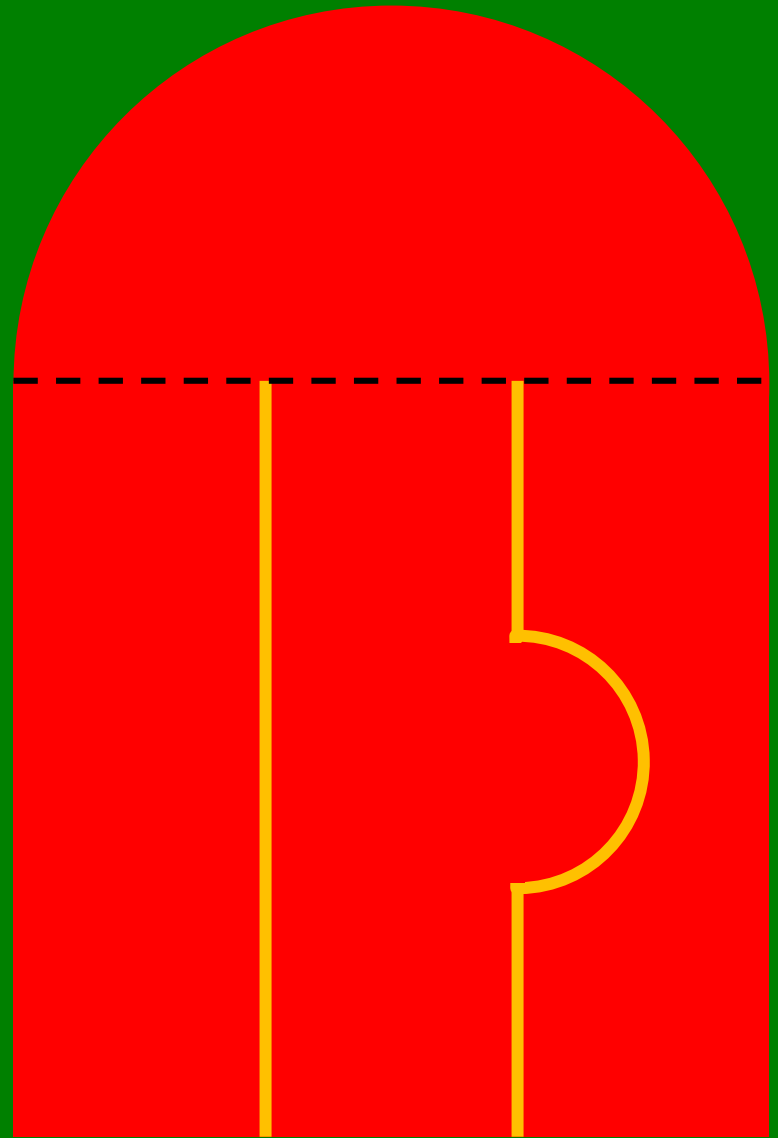
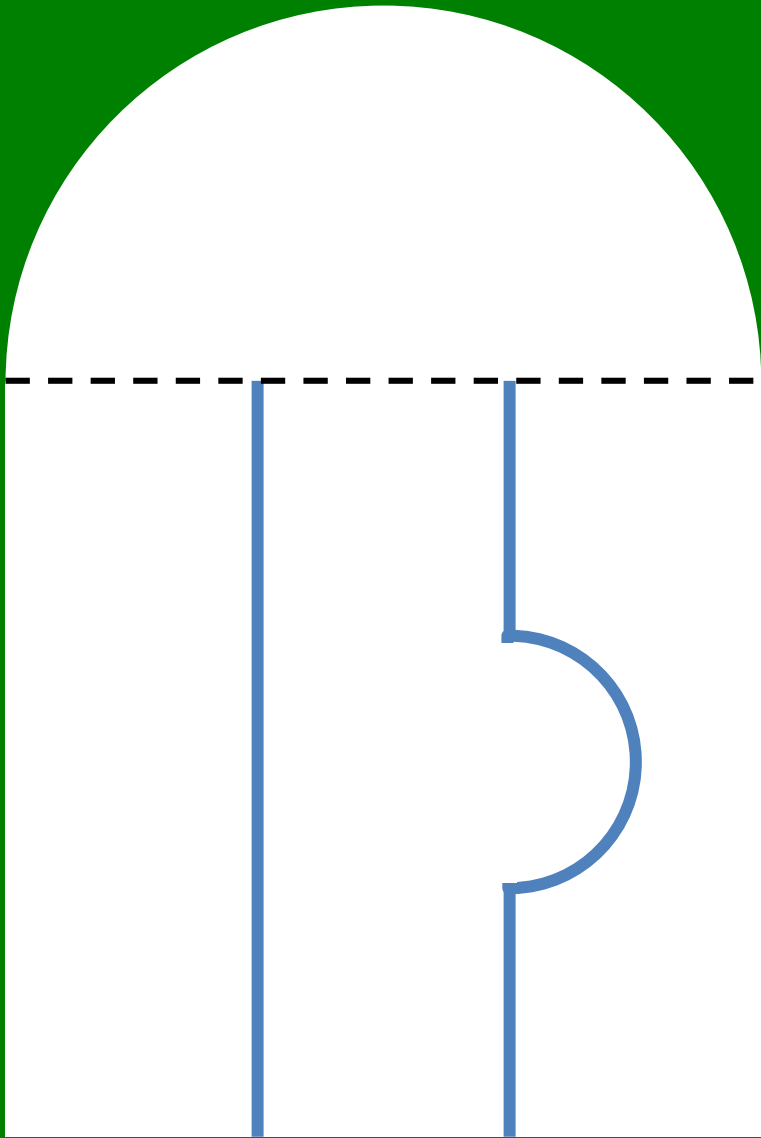

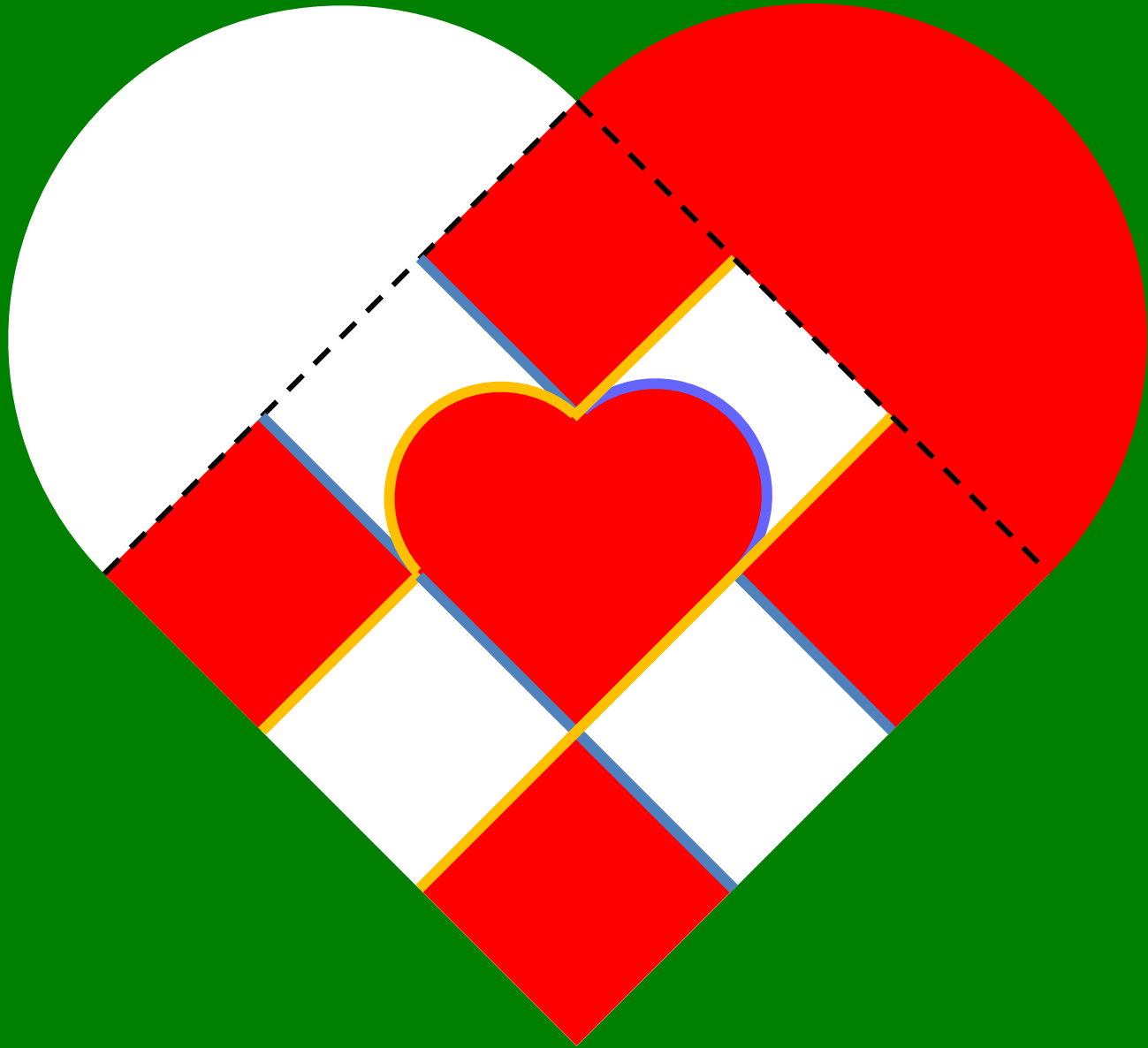



**SANTA**

# 1 Flettede Julehjerter

- med bogstaver

Forsidetekst

Bagsidetekst

Opdater

- 4 Tilgængelige tegn
- A B C D E
  - F G H I J
  - K L M N O
  - P Q R S T
  - U V W X Y
  - Z Æ Ø Å -
  - 0 1 2 3 4
  - 5 6 7 8 9

( [link](#) til denne side)

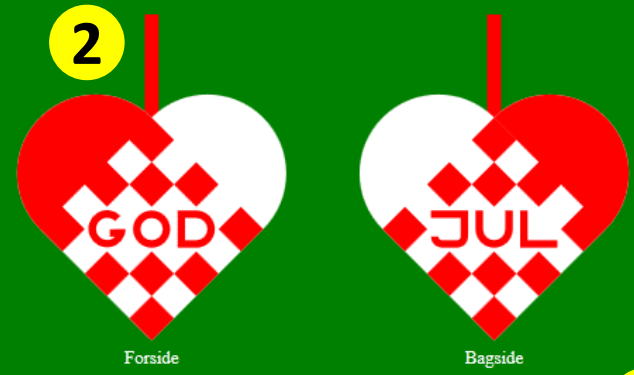

Udskriv rød del

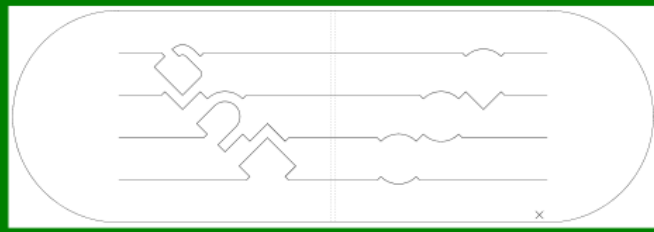

Udskriv hvid del

## Eksempler



Denne webside kræver en nyere browser med SVG understøttelse. Teksten der indtastes for hhv. for- og bagsiden af hjertet vil blive forsøgt placeret vertikalt og horisontalt centreret. Tegnene " " og " " kan bruges til at angive hhv. et tomt felt og et lineskift. Grå felter i skabelonerne angiver felter der skal klippes ud. Fuldt optrukne linier angiver hvor der skal klippes. Der foldes mellem de to stiplede linier så de fuldt optrukne linier bliver foldet indad. De to dele placeres således at de to krydser ligger oven på hinanden og circlen med krydset ikke er synligt inde i hjertet (det er vigtigt at få startet rigtigt pga. af hulleme i bogstaverne "A", "B", "D" etc.). Start med at lave et hjerte med kun et bogstav på den ene side og ingen på den anden side. Der er mange "modhagere" på bogstaverne der gør det svært at flette hjerteme!

# HTML + CSS + PHP + SVG (32 Kb)

- 1 index.php
- style.css
- 2 preview.php
- 3 template.php
- 4 letters.php
- 5 definitions.php





letters.php

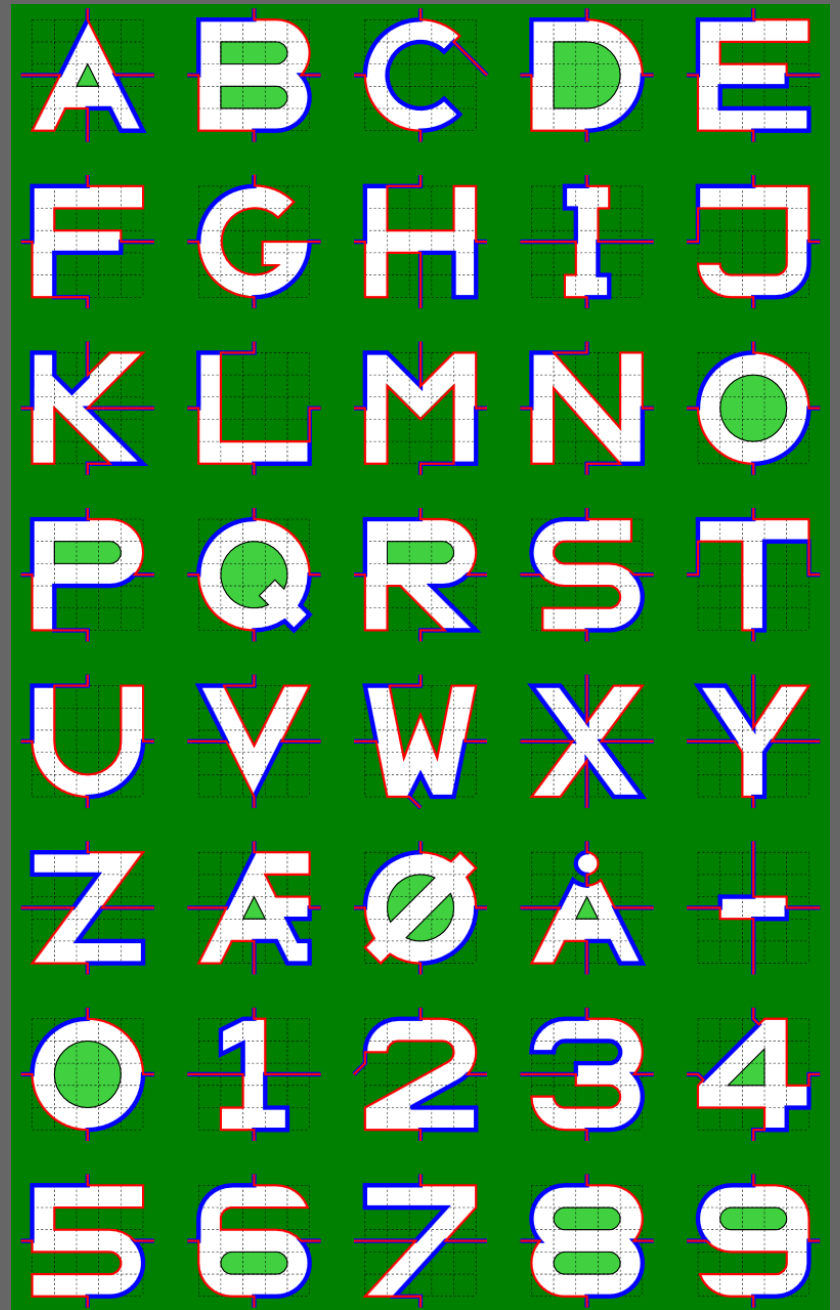

letters.php?debug=1

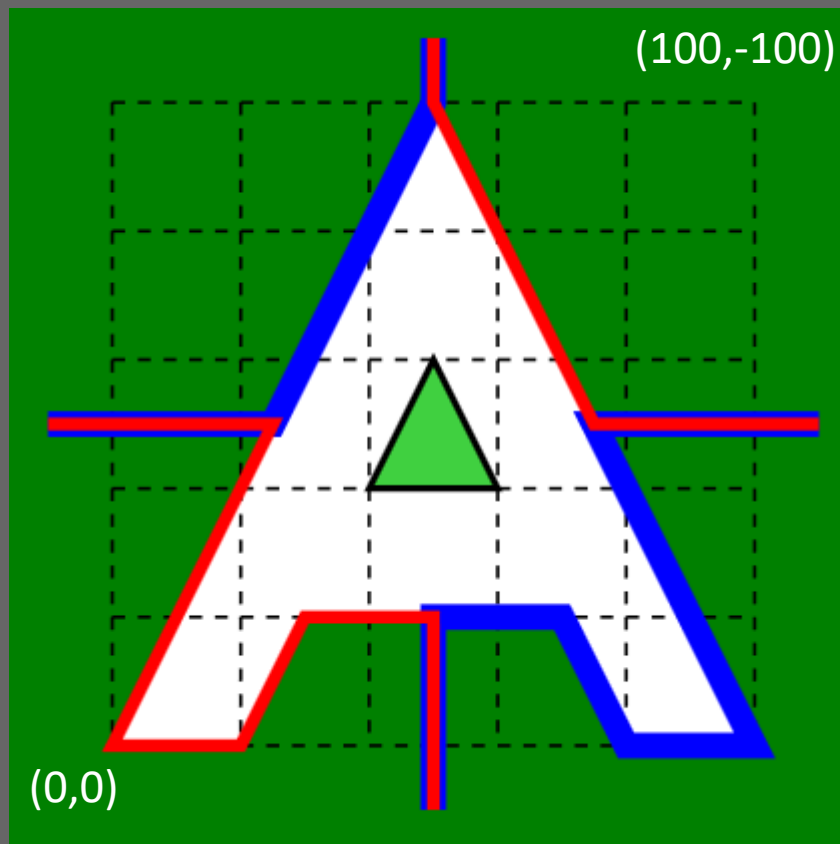

letters.php?debug=1

```

$letter["A"] = 'l 50,-100 l 50,100 l -20,0 l -10,-20 l -40,0 l -10,20 z';
$LUcut["A"] = 'm -10,-50 l 35,0 l 25,-50 l 0,-10
               m 0,120 l 0,-30 l 20,0 l 10,20 l 20,0 l -25,-50 l 35,0';
$DRcut["A"] = 'm 50,10 l 0,-30 l -20,0 l -10,20 l -20,0 l 25,-50 l -35,0
               m 120,0 l -35,0 l -25,-50 l 0,-10';
$hole["A"] = 'm 40,-40 l 10,-20 l 10,20 z';

```

definitions.php

# preview.php



backside=1&text=god&text\_other\_side=jul&debug=1

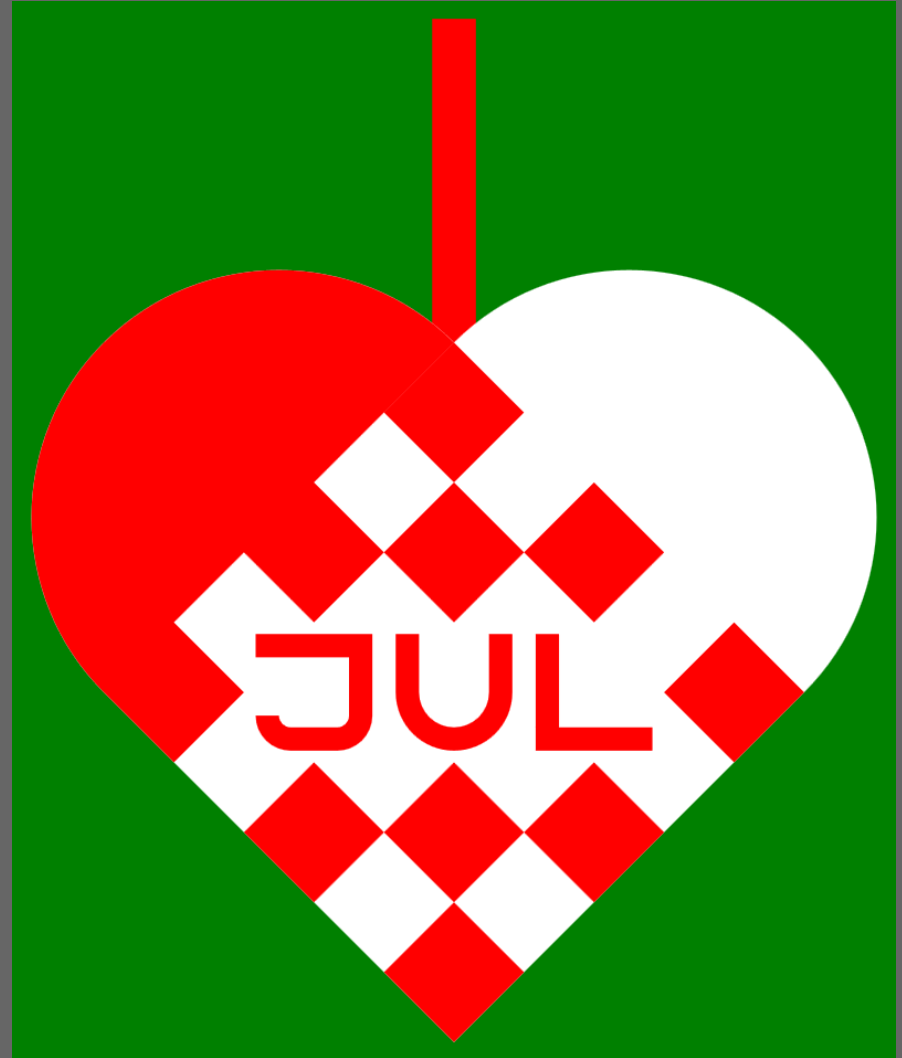

text=jul&text\_other\_side=god

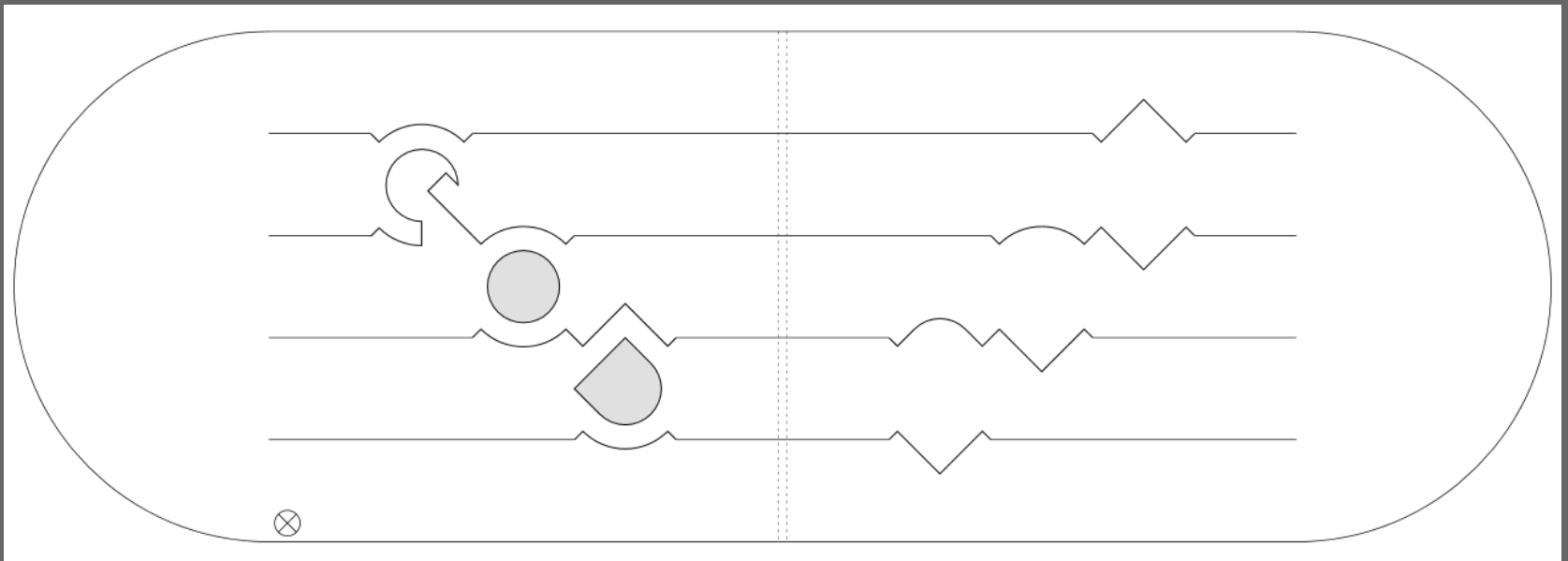

[template.php?piece=0&text\\_front=god&text\\_back=jul](http://template.php?piece=0&text_front=god&text_back=jul)

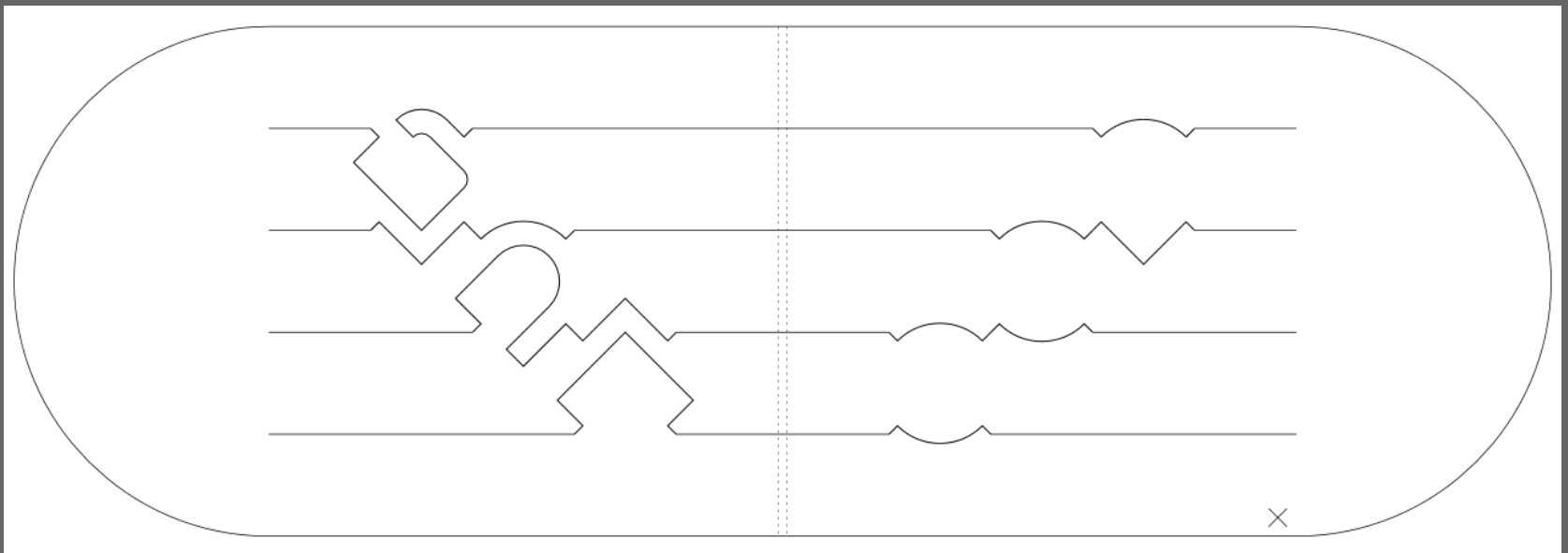

[template.php?piece=1&text\\_front=god&text\\_back=jul](http://template.php?piece=1&text_front=god&text_back=jul)



XMAS

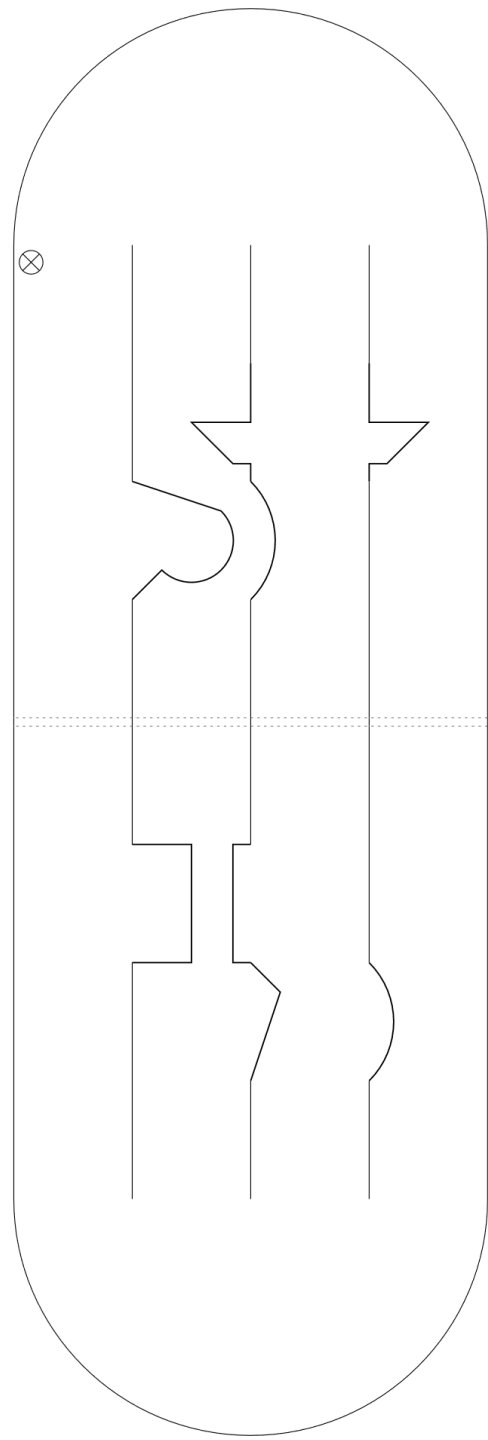
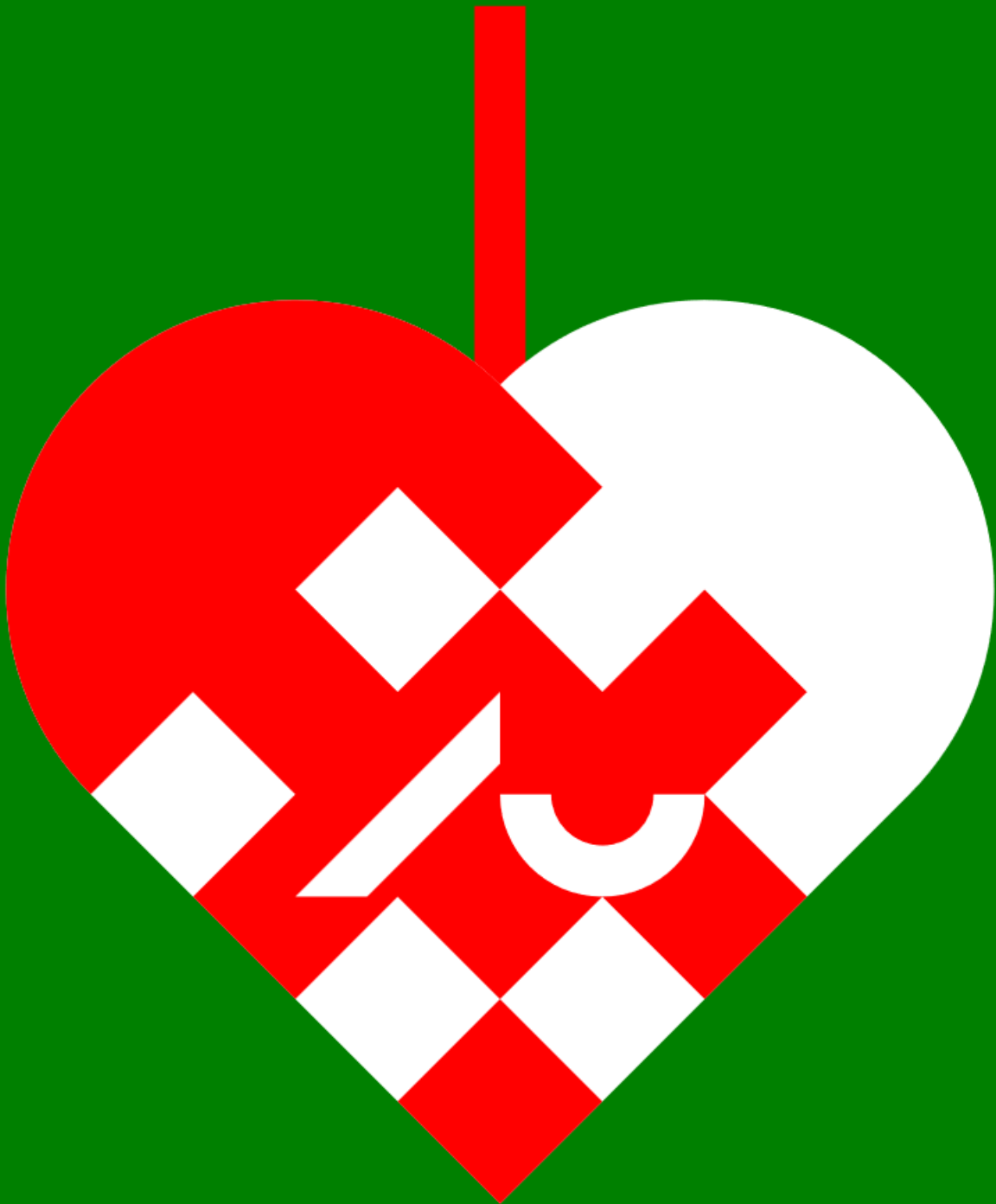



# Hvad er det ?

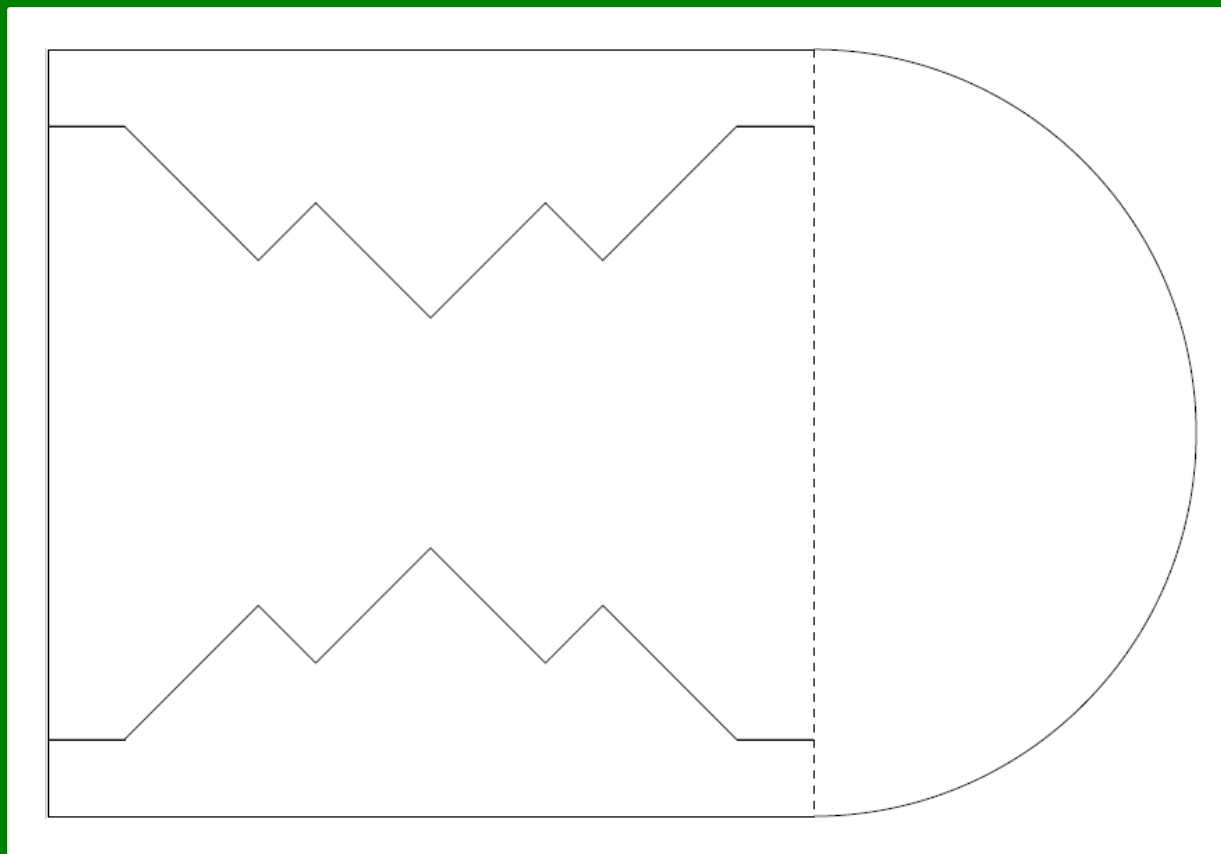

www.rodekors.dk



**God jul. Til alle.**

6 dobbeltkort med  
kuverter.

**54,00 DKK**

[Se mere](#)



**Årets til-fra kort God  
jul Til alle**

8 til/fra kort som du kan  
sætte på dine...

**25,00 DKK**

[Se mere](#)



versionN  
Studiebloggen

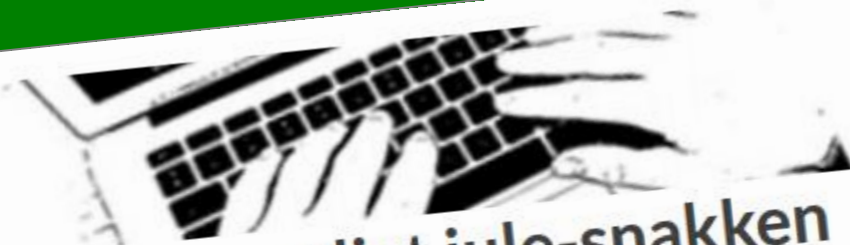

# Sådan drejer du helt naturligt jule-snakken hen på algoritmer

Kræn Hansen @kraenhansen Søndag, 23. december 2012 - 15:00 3



Af Torben Mogensén | Torsdag, 27. december 2012 - 11:18 Blogger

## Snyd?

Gerths program er meget sjovt, men jeg synes det snyder lidt: Når der er "hule" bogstaver såsom O, D og lignende, klippes det indre helt væk. I "rigtige" hjerter skal alle dele af mønstret opnås ved fletning (sådan, at der er to lag papir i hele motivfeltet). Men det er selvfølgelig min egen ret strikse fortolkning. Andre kan slække lige så tosset de vil på kravene. :-)

5 0

# Torben Ægidius Mogensen

[hjemmesider.diku.dk/~torbenm/hearts.pdf](http://www.diku.dk/~torbenm/hearts.pdf)

## Braided Christmas Hearts

Torben Mogensen

<http://www.diku.dk/~torbenm/hearts.pdf>

December 14, 2015

### Abstract

For over 100 years, it has been a Danish tradition to make heart-shaped Christmas ornaments of coloured paper. Tradition says that the fairy-tale author Hans Christian Andersen originated the idea, and the oldest preserved Christmas heart dating from the 1860s is, indeed, from his hand and is exhibited in the H.C. Andersen museum in Odense, Denmark.

The tradition spread in the early 20th century and patterns evolved from the original simple square tiling to more complex patterns. The hearts are traditionally used as ornaments on Christmas trees and, since they can open as small baskets, they are sometimes filled with candy.

This is a short tutorial for making you own Christmas hearts in the Danish tradition, starting with the original checker-board patterns and continuing to more complex patterns. The aim is to make the reader able to design his or her own complex patterns.

## 1 The Traditional Christmas Heart

The oldest preserved Christmas heart made by the fairy-tale author Hans Christian Andersen in the 1860s is shown below:

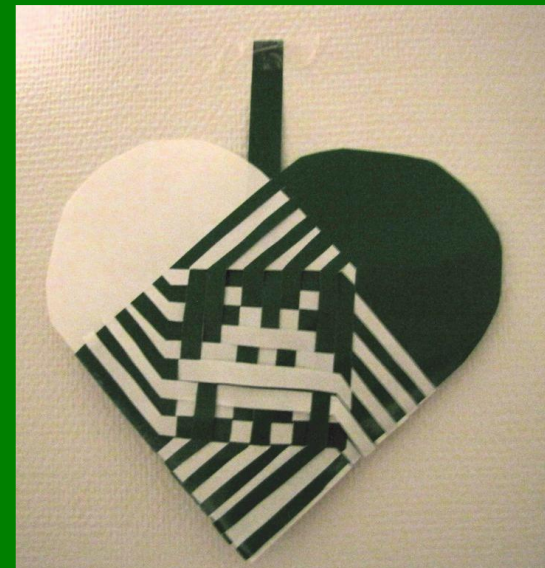
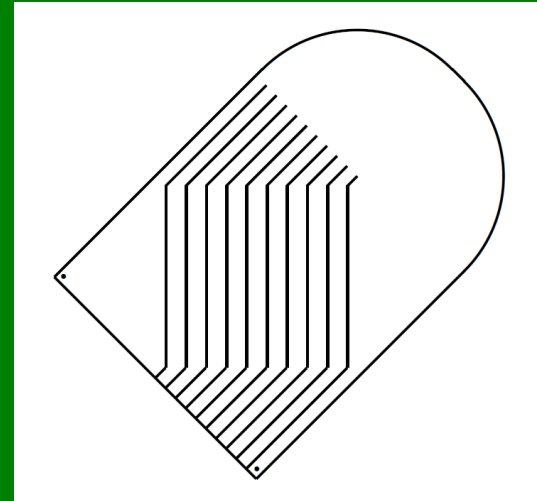

**Julehjerte Designer**



**Gerth Stølting Brodal**

Aarhus Universitet

[www.cs.au.dk/~gerth/julehjerter](http://www.cs.au.dk/~gerth/julehjerter)